

Potain GTMR 386B

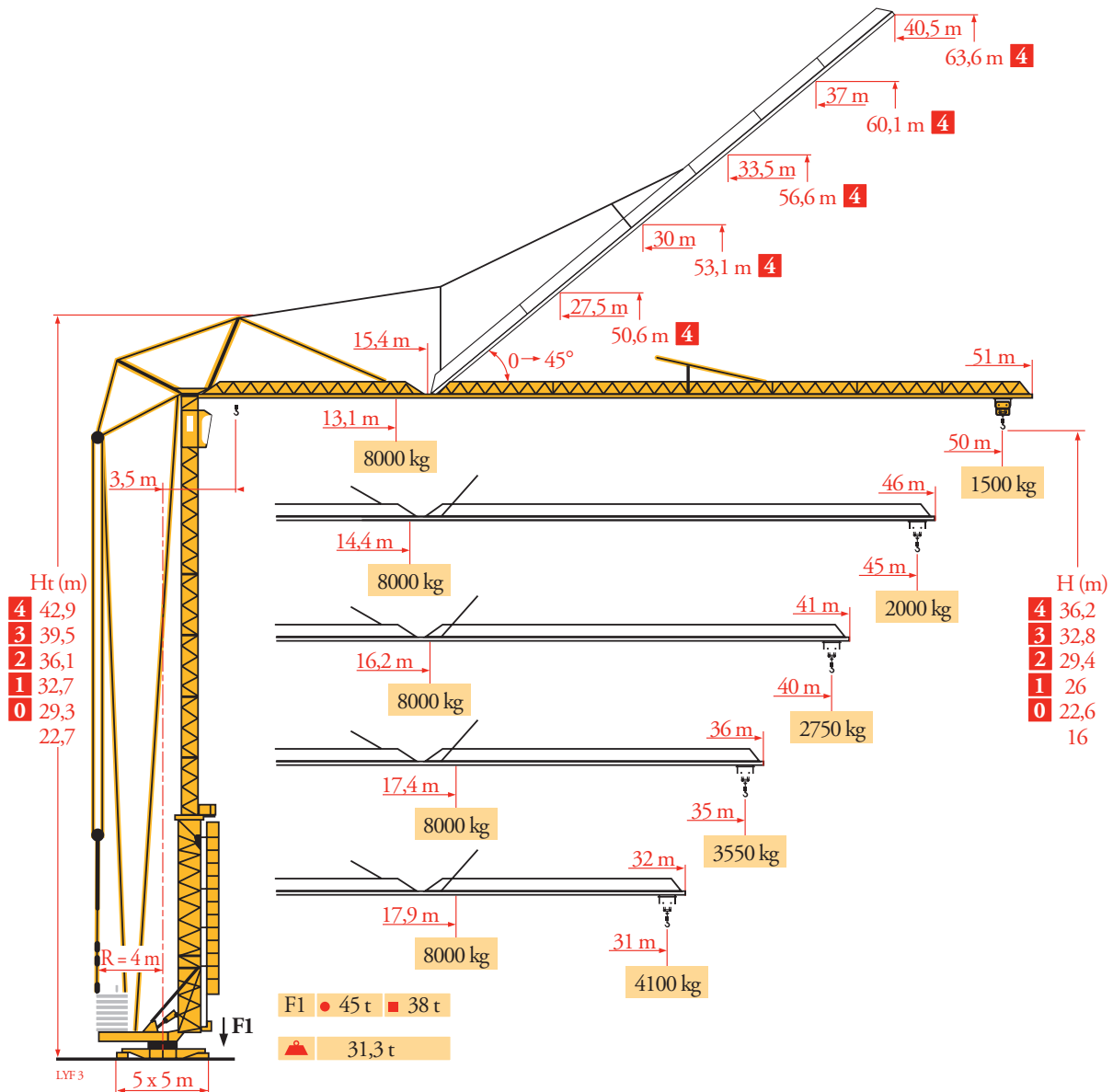

Courbes de charges
Lastkurven
Load diagrams
Curvas de cargas
Curve di carico
Curva de cargas
Диаграммы грузоподъемностей

LVF 3

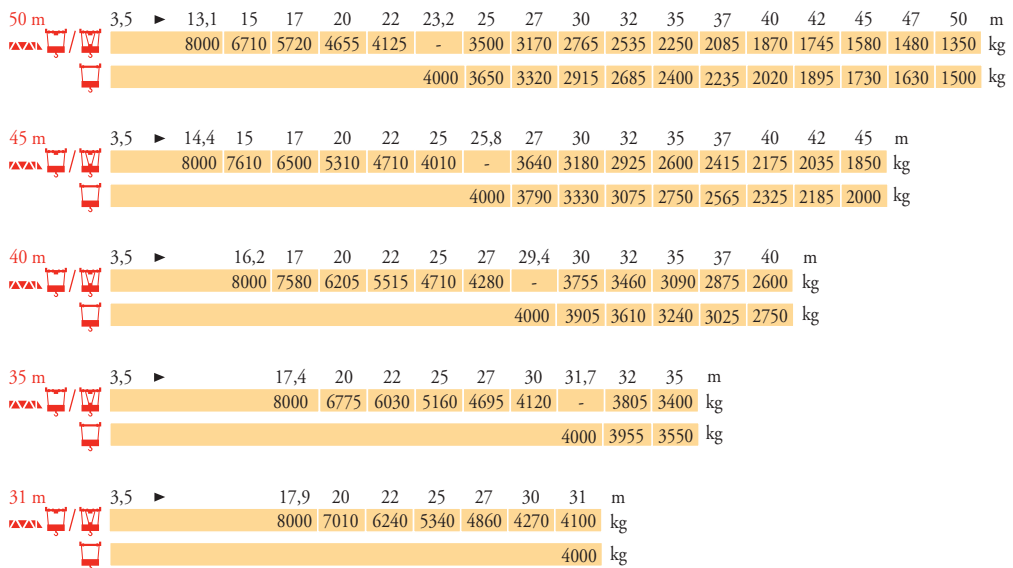

Flèche relevée
Ausleger in Steilstellung
Luffing jib
Flecha izada
Braccio impennato
Lança inclinada
Маховая стрела

LVF 3

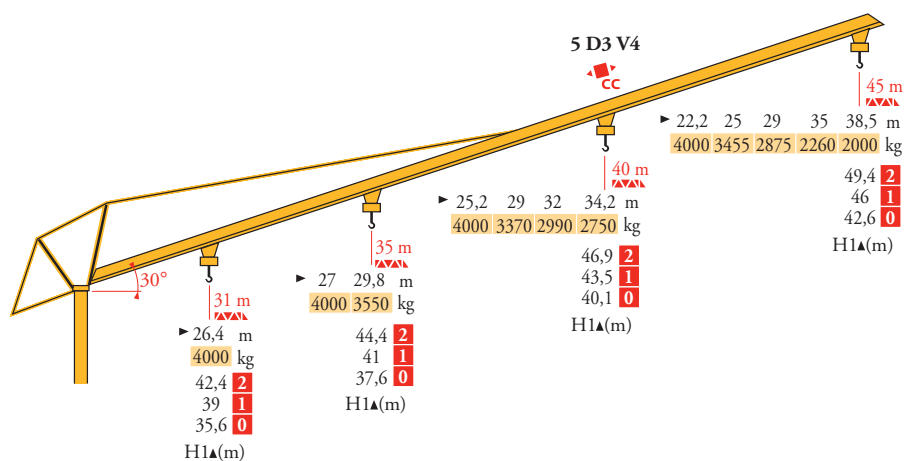

FR



Chariot distributeur et courbes de charges
Réactions en service
Réactions hors service



A vide sans lest (ni train de transport) avec flèche et hauteur maximum.

DE

Verfahrbare Laufkatze und Lastkurven
Reaktionskräfte in Betrieb
Reaktionskräfte außer Betrieb

Ohne Last, Ballast (und Transportachse), mit Maximalausleger und Maximalhöhe.

EN

Traversing trolley and load diagrams
Reactions in service
Reactions out of service

Without load, ballast (or transport axes), with maximum jib and maximum height.

ES

Carro distribuidor y curvas de cargas
Reacciones en servicio
Reacciones fuera de servicio

Sin carga, sin lastre, (ni tren de transporte), flecha y altura máxima.

IT

Carrellino distributore e curve di carico
Reazioni in servizio
Reazioni fuori servizio

A vuoto, senza zavorra (ne assali di trasporto) con braccio massimo e altezza massima.

PT

Carro distribuidor e curva de cargas
Reacções em serviço
Reacções fora de serviço

Sem carga (nem trem de transporte)- sem lastro com lança e altura máximas.















RU

Грузовая тележка и диаграммы грузоподъемностей
Реакции при работе
Реакции в покое

Вес без груза, балласта (или транспортных осей), с максимальной длиной стрелы и максимальной высотой.

Mécanismes
Antriebe
Mechanisms
Mecanismos
Meccanismi
Mecanismos
Механизмы

LYF4



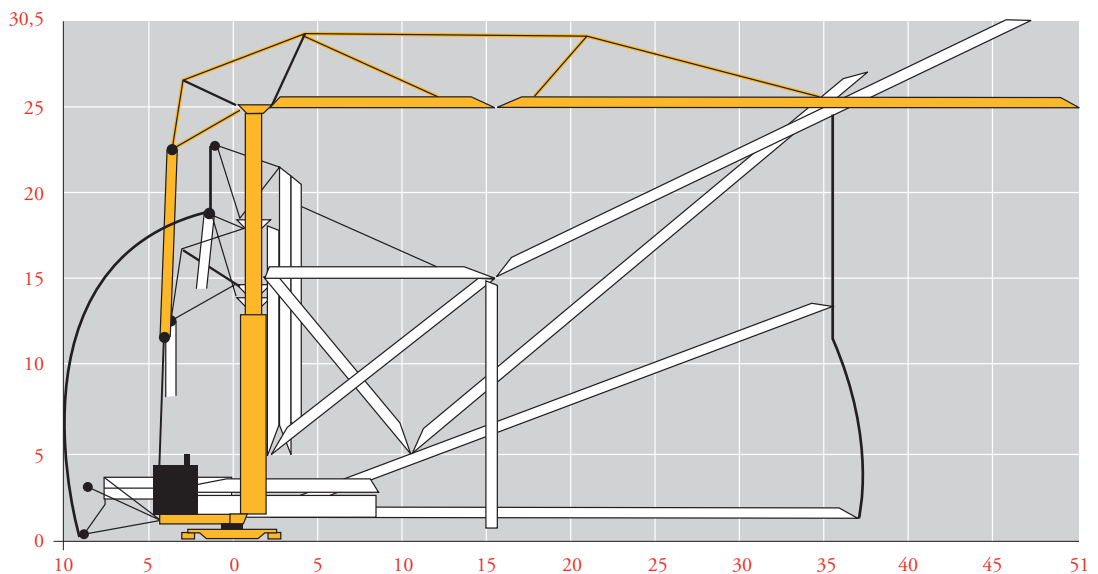

									ch - PS hp	kW
										
	33 PC 20	m/min	5,4	30	60	2,7	15	30	33	24
		kg	4000	4000	2000	8000	8000	4000		
	33 LVF 20	m/min	5,4	31	62	2,7	15,5	31	33	24
		kg	4000	4000	2000	8000	8000	4000		
	5 D3 V4	m/min	15 - 30 - 58						5,5	4
	RCV 62	tr/min U/min rpm	0 → 0,8						8	5,9
 R ≥ 8 m	H ≤ 32,8 m	m/min	25						2 x 4	2 x 3
CEI 38 			IEC 38			kVA 				
400 V (+6% -10%) 50 Hz						50 kVA				

Montage
Montage
Erection
Montaje
Montaggio
Montagem
Монтаж

LYF3



FR

-  Levage
-  Distribution
-  Orientation
-  Translation

DE

- Heben
- Katzfahren
- Schwenken
- Kranfahren

EN

- Hoisting
- Trolleying
- Slewing
- Travelling

ES

- Elevación
- Distribución
- Orientación
- Traslación

IT

- Sollevamento
- Distribuzione
- Rotazione
- Traslazione

PT

- Elevação
- Distribuição
- Rotação
- Translação

RU

- Подъем
- Перемещение каретки
- Поворот
- Перемещение крана

Transport
Transport
Transport
Transporte
Trasporto
Transporte
Транспортировка

LYF 3

S4/S215M
S5B/J215M

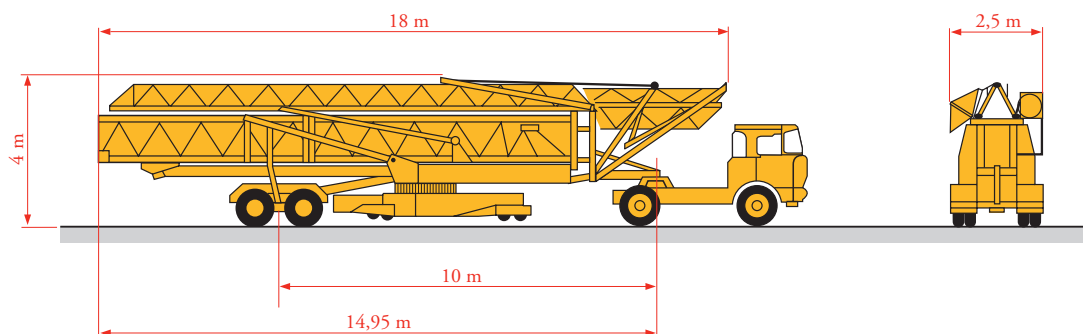

Document commercial non contractuel. Pour toute information technique se référer à la notice correspondante.

Unverbindliches Vertriebsdokument. Für technische Informationen, siehe die entsprechenden Anweisungen.

This commercial document is not legally binding. For any technical information, please refer to the corresponding instructions.

Documento commercial no contractual. Para cualquier información técnica, ver la noticia correspondiente.

Documento commerciale non vincolante, per tutte le informazioni tecniche fare riferimento al catalogo istruzioni.

Documento comercial não contratual. Para qualquer informação técnica complementar consultar as respectivas instruções.

Этот коммерческий документ не является юридически обязательным. Для получения технической информации, см. соответствующие инструкции.



**Nordisk Kran
uthyrning AB**

Manitowoc

Manitowoc - Americas - World Headquarters
2400 S. 44th Street • Manitowoc • WI 54220 USA
Tel: +1 920 684 4410 • Fax: +1 920 652 9778

Manitowoc - Europe, Middle East & Africa
Manitowoc France SAS
18, rue de Charbonnières B.P. 173 • 69132 ECULLY Cedex • FRANCE
Tel: +33 (0)4 72 18 20 20 • Fax: +33 (0)4 72 18 20 00

Manitowoc - Asia Pacific
16F Xu Hui Yuan Building,
1089 Zhongshan No.2 Road (S) • Shanghai 200030 China
Tel: +86 21 6457 0066 • Fax: +86 21 6457 4955

GTMR 386B

REF. 2003 48 LYF 6